

THE GRINDER²[®]

THE COMPACT, **CUSTOMIZABLE**
GRINDER WITH COLOSSAL POWER

U.S. & FOREIGN PATENTS ISSUED AND PENDING



Manufactured for Worldwide Compatibility



TECHNIGLASS

DESIGNED, ENGINEERED & ASSEMBLED IN THE USA

THE GRINDER₂[®]

SPACE SAVING DESIGN AND WHISPER QUIET OPERATION

Designed for space saving efficiency and exemplary performance, THE GRINDER₂ is an advanced tool for professionals, hobbyists and classroom settings of limited space. Supported by a super quiet, powerful motor boasting a torque of 57 oz/in at 4500 RPM; Vibration Dampening Technology absorbs shock and provides added stability to maintain an extremely quiet whisper operation for the most pleasurable grinding. With optional accessories, THE GRINDER₂ can be customized with innovative technology only offered by Techniglass.

**EXPERIENCE THE ROBUST POWER
ALONG WITH AN ULTRA-SMOOTH
AND CHIP-FREE GRIND.**



Work Surface Dimensions: 11.5" x 9.5" (29x24cm)

Included with 
THE **GRINDER₂**[®]

FEATURES:

- Powerful DC Brushless Motor •
- 4500 RPM •
- 110-220 VAC for Universal Use •
- Low Profile, Contemporary Design •
- Vibration Control •
- Built-In Accessory Drawer •
- 5 Year Limited Warranty •

TECHNIGLASS

DESIGNED, ENGINEERED & ASSEMBLED IN THE USA

THE **Quick-Fit Bit**[®] **SYSTEM**

NO KEYS REQUIRED, REUSABLE HOLDER



3/4" Included with THE GRINDER₂

PREVENTS CHIPPING, 100% UTILIZATION

Engineered with an industrial elastomer, the patented Quick-Fit Bit System absorbs grinding vibration and can be adjusted vertically on the grinder shaft, enabling full utilization of the grinding surface. Changing bits is fast, even for individuals with reduced grip strength. Replacement sleeves available in Rapid, Standard, Fine and Ultra Fine varieties.

THE **Aqua Flow System**[®]

NO SPONGE NEEDED

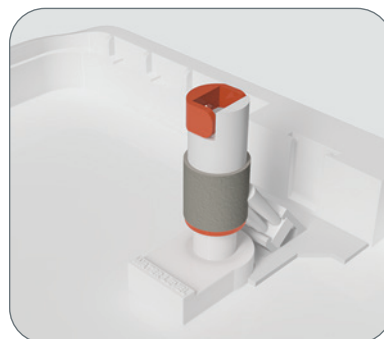

CONTINUOUS WATER FLOW

The patented Aqua Flow System brush bristles transfer water from the reservoir to grinding bit heads via capillary action, requiring addition of water only at the onset of grinding.

Included with THE GRINDER₂[®]

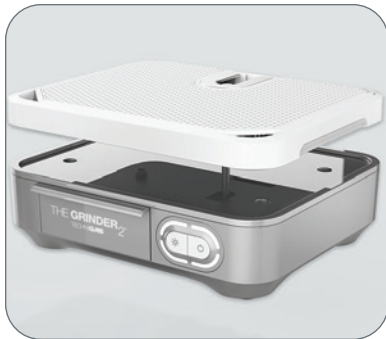

REMOVABLE WATER TRAY

Unlike other grinders, the water reservoir comes equipped with a removable water tray which can be easily emptied and cleaned after use. With handles on each side, the lift-out tray makes cleanup simple and safe. Eliminate carrying the entire grinder to the sink or potentially spilling its contents on floors and work surfaces.

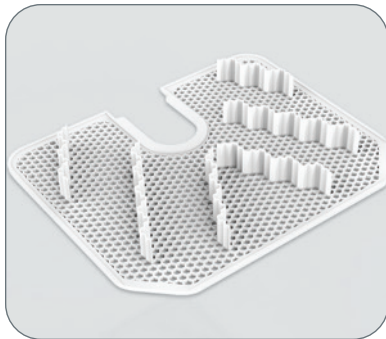

WATER WAVE STABILIZER AND SUPPORT SYSTEM

The patented and uniquely designed main grid includes supports and baffles on the underside to stabilize work surface and limit water movement during tray transport.

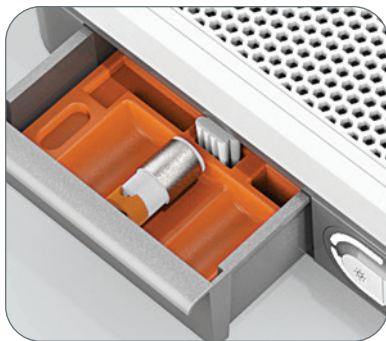

ACCESSORY DRAWER

The exclusive, compartmentalized and built-in drawer is a space saving way to store spare bits, Aqua Flow System[®] replacement brushes and more!

The ultramodern, low profile compact design of **THE GRINDER₂** accommodates settings of limited space without compromising power.

Included with THE GRINDER₂[®]

EVERWEAR[®] BIT GUARD

Made from stainless steel, the bit guard allows for a secure fit between the Quick-Fit Bit[®] and the Grid.

3/4" Everwear Bit Guard Included, 1" Everwear Bit Guard Optional.

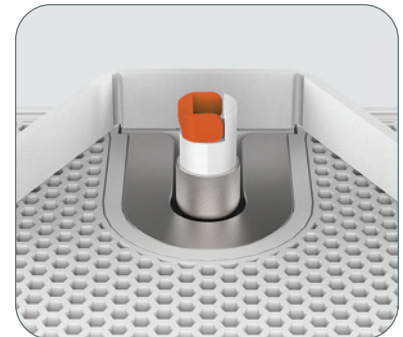

EZ-VIEW[®] WINDOWS & LIFT GRID

It's important to keep a sufficient flow of water to the bit head while grinding. Fill to the Water Level Mark indicated inside the reservoir to ensure an optimal amount of water and prevent overfilling. Reservoir water level can be continuously monitored through the EZ-View Windows. The cut outs allow the Lift Grid to be easily removed for addition of water or cleaning.



UNIVERSAL COMPATIBILITY

Electric voltages and frequencies vary by country. THE GRINDER₂ is rated for universal voltage 110 – 220 VAC and is equipped with a 5 ft. (1.5 m) durable and removable 3-prong cord available for US, UK, AUS and EU outlets.



NO FOOT PEDAL NEEDED

- The inventive design of THE GRINDER₂ results in minimal sound when idling.
- Our proprietary motor is designed to maintain a consistent low temperature, which prevents overheating.
- Consumption of electricity spent is dramatically reduced. THE GRINDER₂ uses 24X less electricity than other grinders.

TECHNIGLASS
www.techniglass.com

Custom build THE GRINDER₂[®]

OPTIONAL Accessories

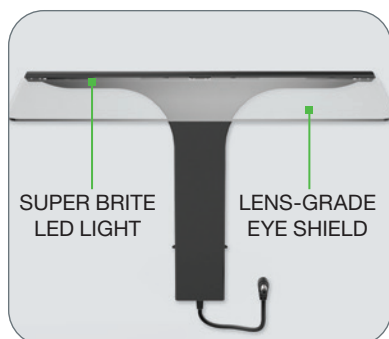

ORDER #: G2S-KIT LUMISHIELD

THE LUMISHIELD₂[®] LED LIGHT

The patent pending LED illuminated lens-grade eye shield can be easily attached. It provides protection from minute glass particles that become airborne and also casts an even amount of light across the work surface.

Equipped with an energy efficient, super-brite LED light to best illuminate the project you are working on.

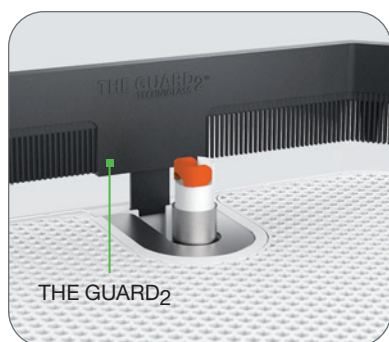

ORDER #: G2S-SPLASH GUARD

THE GUARD₂[®] SPLASH CURTAIN

The patented wear-resistant splash curtain is designed to maintain a clean and dry work surface. Glass pieces of unlimited length easily slide through the bristles which capture debris and water returning to the reservoir.

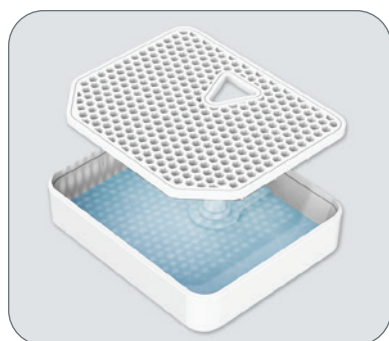

ORDER #: GS-Kit MINI G

THE MINI G[®] ELEVATED WORK SURFACE AND MINI G[®] BIT SYSTEM

The secondary platform with water reservoir is sold separately and can be placed atop the main grid enabling use of 1/4" and 1/8" spindle top bits. The Mini G Bit System also includes a Shaft Water Seal.

- Platform Dimensions: 1.2" H x 5.8" W x 4.8" D (3cm x 14.7cm x 12.2cm)
- EZ-View Window & Lift Grid: Effortlessly monitor the water level or remove the Lift Grid for the addition of water or cleaning

Included with THE MINI G is an orange base brush insert for the Aqua Flow System. This orange brush should **ONLY** be used for the MINI G upper platform.

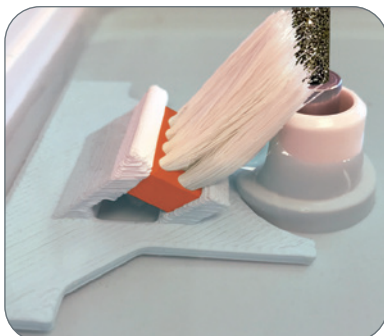

ORDER #: G-MB KIT

THE GRINDER²[®]

U.S. & FOREIGN PATENTS ISSUED & PENDING

Compact &
Contemporary
Low Profile
Bold Design



THE CUSTOM BUILT GRINDER!

OPTIONAL

Super Brite LED Light

OPTIONAL

Lens-grade Eye Shield

OPTIONAL

Splash Curtain

3/4" Quick-Fit Bit[®] System

3/4" Stainless Steel
Bit Guard

EZ-View[®] Window

Accessory Drawer

Light Switch

Activates with purchase of Lumishield²[®]

Power Switch

Removable Water Tray

OPTIONAL

THE MINI G[®] Elevated Work Surface

1/4" & 1/8" MINI G[®] Bits

ALSO INCLUDED:

Aqua Flow System[®] and Brush

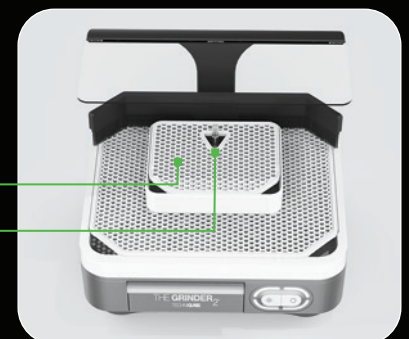

THE GRINDER²[®]



INCLUDED ACCESSORIES

Product	Techniglass Item #
Quick-Fit Bit [®] System 200 - 3/4"	QFBS-200-3/4
Aqua Flow System [®]	AFS-TG
Everwear [®] Bit Guard - 3/4"	GS-BIT GUARD 3/4"
Mini Splash Guard	G2S-MINI GUARD
Power Cord	G-PCORD US
	G-PCORD UK
	G-PCORD EU
	G-PCORD AUS

OPTIONAL ACCESSORIES

Product	Techniglass Item #
THE LUMISHIELD ² [®] LED Illuminated Eye Shield	G2S-KIT LUMISHIELD
THE GUARD ² [®] Splash Curtain	G2S-SPLASH GUARD
Mini G [®] Elevated Work Surface	GS-Kit MINI G
Mini G [®] Bit System	G-MB KIT
Quick-Fit Bit [®] System 200 - 1"	QFBS-200-1
Everwear [®] Bit Guard - 1"	GS-BIT GUARD 1"